



AMAZONE

Trailed shallow cultivator ***Cobra***



Cobra trailed shallow cultivator

Shallow soil disturbance – Intensive mixing



The Cobra is a 6-stagger, shallow tine cultivator in working widths of 6 m and 7 m and offers a multitude of applications. It is the all-rounder for shallow soil tillage from catch crop destruction and shallow stubble cultivation to seedbed preparation. Due to the wide range of pre-working tools, shares and rollers, the implement can be matched to virtually any field conditions.



	Page
The advantages at a glance	4
Versatile shallow cultivator	6
Overview	8
Soil-engaging metal	10
Tine and share systems	12
Drawbar and mounting Chassis	14
Depth control	16
Roller range	18
Consolidation roller or double harrow	20
Technical data	22

Cobra trailed shallow cultivator

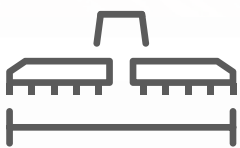

6 to 7 m



4 to 13 cm



Up to 16 km/h



13.3 cm

The advantages at a glance:

- ⊕ High-output, universal shallow cultivator for shallow to medium-deep soil tillage up to 13 cm
- ⊕ Intensive incorporation of crop residues as a result of the 6-stagger layout with ECO leaf-spring tines
- ⊕ Exact depth control via support wheels and the following roller
- ⊕ Full-surface movement at shallow working thanks to the large duckfoot share overlap
- ⊕ Perfect handling of organic matter and catch crops thanks to the front knife roller
- ⊕ Even, fine-crumbed seedbed thanks to the front Crushboard and levelling element in front of the roller
- ⊕ Perfect weed control thanks to the optional trailing double harrow

MORE INFORMATION

www.amazone.net/cobra



PRODUCT FILM

Find out more

A versatile shallow cultivator

For intelligent crop production



Why use a shallow cultivator?

With the launch of the Cobra shallow cultivator, Amazone offers a new machine which is characterised particularly by its universal application. The Cobra is not only ideal in achieving its main goal of mechanical weed control, it can also be used on the farm all year round. It comes into its own not just in shallow stubble cultivation, but also shows its strengths in the second or third deeper tillage pass, catch crop destruction as well as for seedbed preparation.

The large selection of different pre-working tools, tine variants and following rollers or harrows allows the Cobra to provide the ideal combination of cultivation elements for any location and every farming system.

The benefits:

- ✔ Versatile machine for a wide range of soil tillage tasks
- ✔ Individually configurable
- ✔ Long lifespan thanks to the robust construction

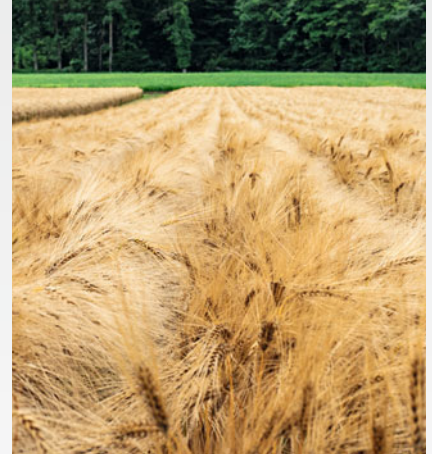

Scope of operation	Catch crop destruction	Pass 1:	Pass 2:	Seedbed preparation
Objectives	<ul style="list-style-type: none"> • Stop plant growth • Initiate rotting 	<ul style="list-style-type: none"> • Breaking the capillarity • Promote germination of volunteer grains and weed seeds 	<ul style="list-style-type: none"> • Weed control 	<ul style="list-style-type: none"> • Weed control • Seedbed preparation
Implementation	<ul style="list-style-type: none"> • Shallow working • Shredding • Mixing • Reconsolidating 	<ul style="list-style-type: none"> • Shallow working • Mixing • Reconsolidating 	<ul style="list-style-type: none"> • Shallow working • Mixing 	<ul style="list-style-type: none"> • Shallow working • Fine soil production • Mixing • Levelling • Reconsolidating

The objective of catch crop destruction is to stop plant growth and initiate rotting of the catch crop, for instance, in the spring before maize sowing. This is particularly effective with the Cobra, thanks to optional knife rollers. These provide a chevron blade arrangement that prevent lateral pull. The knives can be turned, thereby halving the wear costs, which means that the Cobra is even more cost-effective to run. The duckfoot shares move soil across the full working width and also provide a clean cutting action and ensure good mixing of the soil and the organic matter.

Full-surface movement and therefore full-surface cutting of stubble or weeds are also extremely important for good shallow stubble cultivation. AMAZONE offers various duckfoot shares in a width of 220 mm, meaning that sufficient overlapping of the shares is guaranteed under any conditions based on a tine spacing of 13.3 cm.

The large selection of following rollers enables the soil to be optimally reconsolidated, in order to make volunteer grains germinate.

The objective of the second pass is to control germinated weeds. The increase in resistance to and the reduction in plant protection agents means that mechanical weed control during a second pass is steadily growing in importance. The duckfoot shares undercut the weeds across the full working width. Thanks to the option of the double harrow as an alternative to the following roller, the harrow pulls out the weeds without any further reconsolidation. The germinated weeds and volunteers lie exposed on the soil surface and die.

The seedbed generates the foundation for good field emergence. A large amount of fine soil is produced in the mix by the vibration of the ECO leaf-spring tines. This provides optimum germination conditions for the seed. The field is optimally levelled and reconsolidated thanks to the optional levelling unit in front of the following roller.

Gain the advantage!

AMAZONE Cobra shallow cultivator



① **Drawbar and mounting**

- Rigid or hydraulic drawbar
- A wide range of mounting options from lower link and ball point coupling to various towing eyes

② **Optional pre-working tools**

- Crushboard
- Knife roller



Overview of the Cobra range:

Model	Working width
Cobra 6000-2TX	6.0 m
Cobra 7000-2TX	7.0 m

③ Tine element

- ECO leaf-spring tines
- 6-stagger tine layout
- Tine spacing 13.3 cm
- Frame height 60 cm
- Duckfoot share or narrow share

④ Depth control

- Depth control by means of a parallelogram via the support wheels and roller
- Levelling unit mounted on the roller – adjusts itself automatically when the working depth is set

⑤ Following rollers

- Selection of 9 different following rollers
- Double harrow
- Operation without a roller

Pre-running tool options

The right combination for any application



Cobra 7000-2TX with knife roller

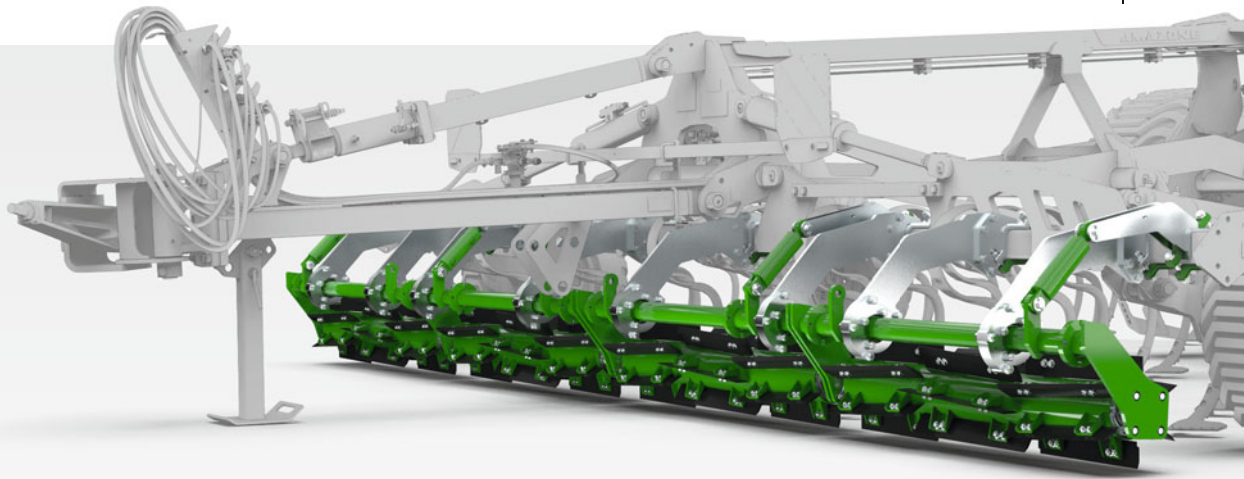

Cobra 6000-2TX with knife roller

Knife roller – shredding and incorporation of crop residues or catch crops

The knife roller on the AMAZONE shallow cultivator provides maximum flexibility for soil tillage. The knife roller enables extremely shallow soil tillage with simultaneous shredding of the stubble, such as during that initial stubble cultivation after rape. However, the knife roller is also ideal for working in tall catch crops, maize or sunflower stubbles. In particular, long stubbles are cut transversely to the direction of travel and then incorporated by means of the following shares.

The knife roller is lowered into the working position from the tractor seat during work. Its division into different segments enables the knife roller to follow the ground contours perfectly, even in uneven terrain, and effectively shred any crop residues across the entire working width.

Advantages of the knife roller

- ✔ Optimum shredding results due to the high circumferential speed with a roller diameter of 330 mm
- ✔ Excellent contour following thanks to individual roller sections
- ✔ No lateral pull during work, as the blades are arranged on the roller in a V-profile
- ✔ Maintenance-free bearings with a long service life thanks to a metallic face seal
- ✔ Insensitive to stones and dirt due to the enclosed design of the roller centre shaft
- ✔ Wear costs halved thanks to reversible knives with two cutting edges, made of tempered drill steel

Crushboard – better levelling and crumbling

The Crushboard is available as an option and achieves an even better levelling and crumbling. This special option enables, for instance, coarse clods on the surface to be broken up after ploughing as well as optimum preparation of the seedbed.

Advantages of the Crushboard

- ✔ Equipped with convenient, infinitely variable, hydraulic depth adjustment and an easy-to-read scale as standard

Crushboard with hydraulic depth adjustment
and a clearly visible scale

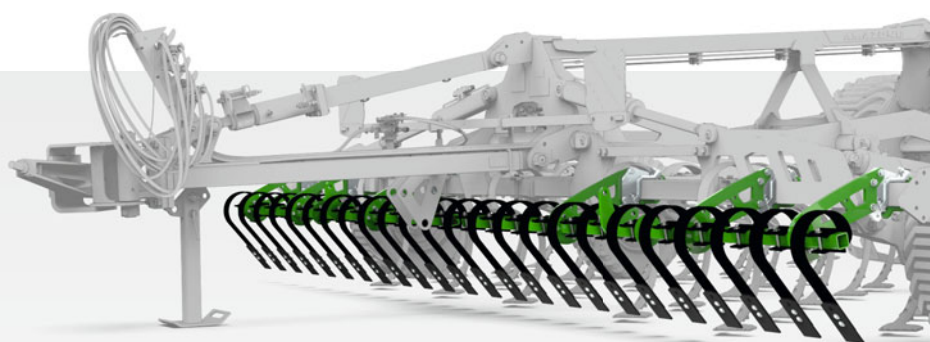

Tine and share systems

Shallow soil movement under any conditions



Cobra 7000-2TX stubble cultivating





ECO leaf-spring tines

The Cobra is the specialist for shallow and medium-deep tillage at working depths from 4 to 13 cm. A large amount of fine soil is produced in the mix by the vibration of the ECO leaf-spring tines. This provides optimum germination conditions, so that volunteer cereals and weed seeds establish well, meaning that they can be combated mechanically in the next working pass. The high proportion of fine soil also has a very positive effect on seedbed preparation. In addition, the ECO leaf-spring tines can adapt very flexibly to the soil conditions and can avoid obstacles.



ECO leaf-spring tines



Duckfoot share 220 mm x 6 mm	Duckfoot share 220 mm x 12 mm	Duckfoot HD share 220 mm x 12 mm	Narrow share 50 mm x 6 mm	Narrow HD share 50 mm x 25 mm
 4 – 8 cm	 4 – 8 cm	 4 – 8 cm	 8 – 13 cm	 8 – 13 cm



Working depths are approximate values and are dependent on the soil conditions

Full-area movement for an optimum quality of work

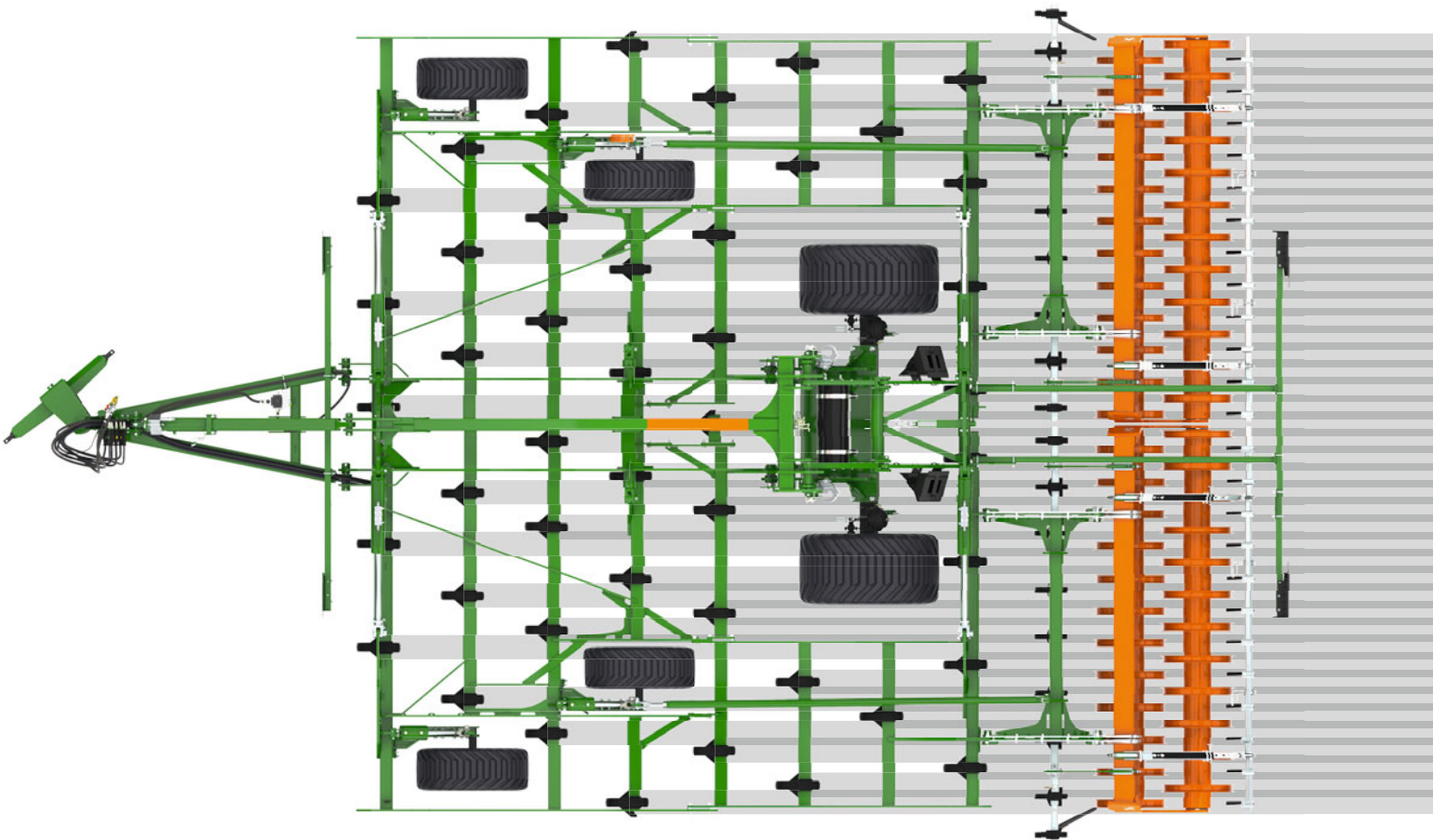

Drawbar and mounting

Drawbar

The slim drawbar of the Cobra offers a very small turning radius both in the field and on the road. The freely movable drawbar when in work means that the Cobra follows the contours without any problems, even in difficult terrain. A rigid and a hydraulic drawbar are available from choice. The hydraulic top tie bar enables the machine to be easily lifted and lowered. A traction control system can also be specified as an option.

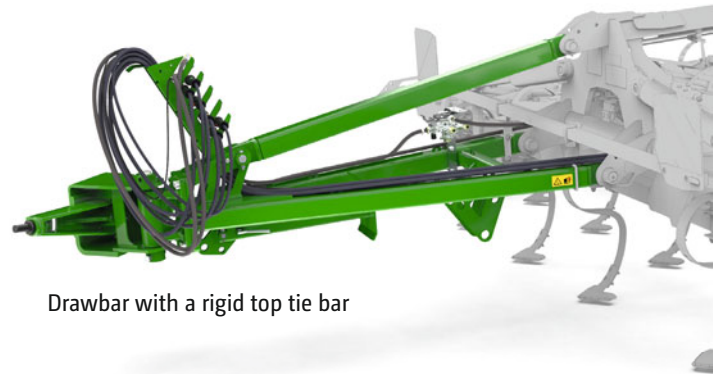

Drawbar with a rigid top tie bar

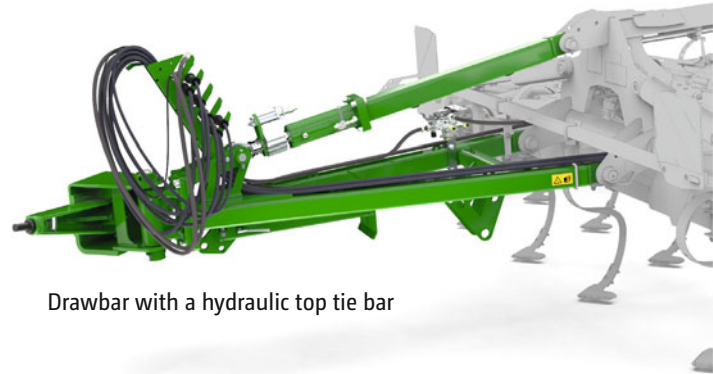

Drawbar with a hydraulic top tie bar

Linkage systems for every tractor

Extensive and convenient mounting and drawbar options to suit any tractor are available for the Cobra. The flange plate allows the easy and quick mounting of any of the linkage options. Furthermore, the linkage category can be quickly changed on the lower link cross shaft.

Only the linkage pins are interchanged for this purpose. As a result, the appropriate linkage can be selected for any tractor, no matter whether Cat. 3, 4N or K700 lower link cross shafts, various towing eyes or the K80 ball coupling are used.



The chassis

Compact on the headland – Comfortable on the road



Cobra 7000-2TX on the road

Axle

Thanks to its oversized wheels (550/45-22.5), the integrated TX centre running gear ensures minimal surface pressure in the field. The compact design and the central positioning of the running gear mean that tight turning on the headland is not a problem. The optimum weight distribution also provides comfortable road transport at speeds of up to 40 km/h.



Quick and tight turning on the headland

Depth control

Precision via support wheels and roller

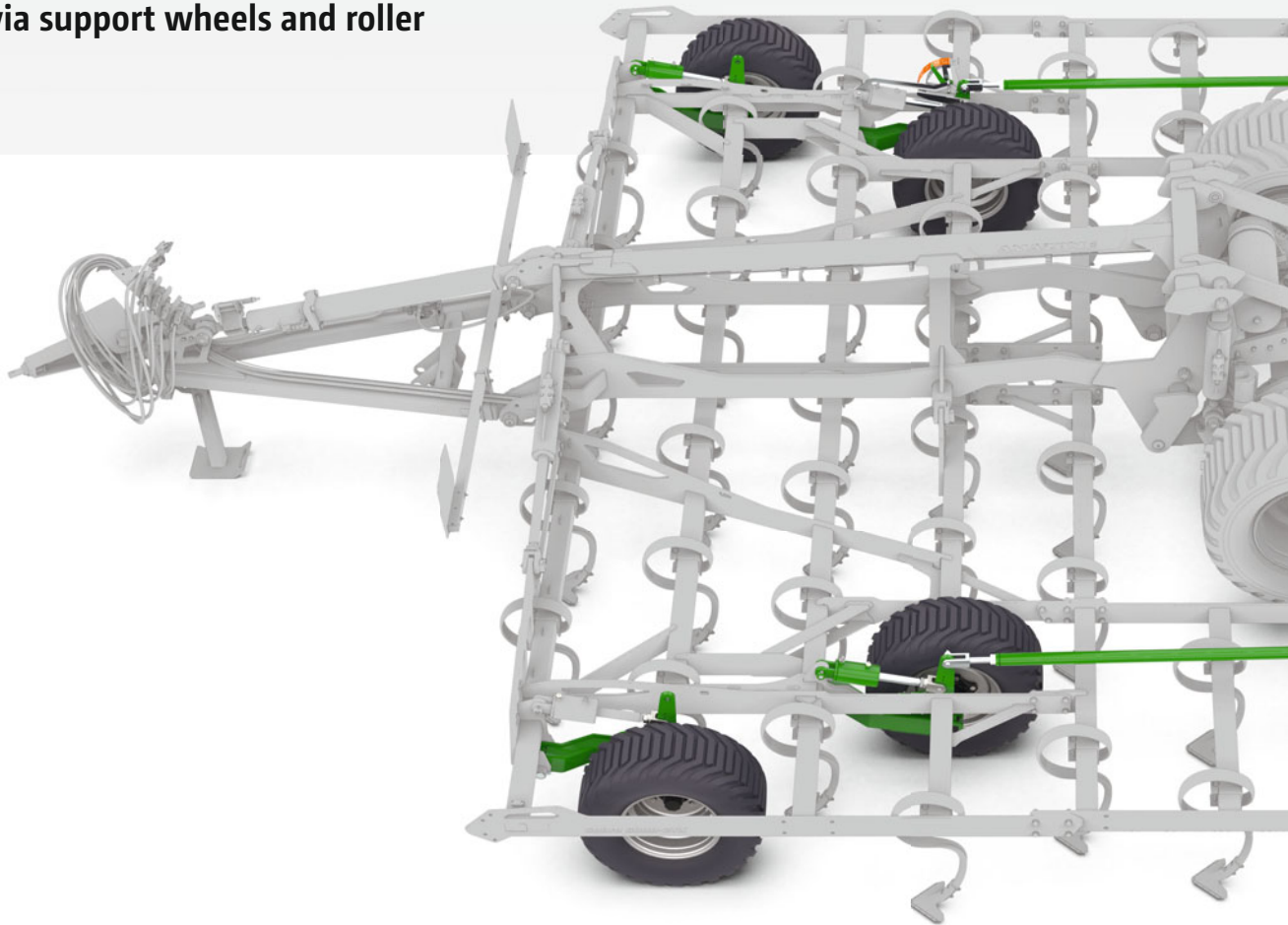

Exact depth control

The depth of the Cobra is adjusted via the following rollers and the large support wheels. These are integrated in the tine element to provide better matching to the topography of the terrain. A coupling rod is mounted at this point to connect the components mechanically, in order to keep the relationship between the support wheels and following roller constant at all times.

The depth is adjusted via both the transport wheels and the front support wheels if the machine is being used without a following roller. A particular feature is that there are tines mounted behind the transport wheels to loosen any tracks produced by the running gear. The running gear is raised completely if the Cobra is being used with following rollers.



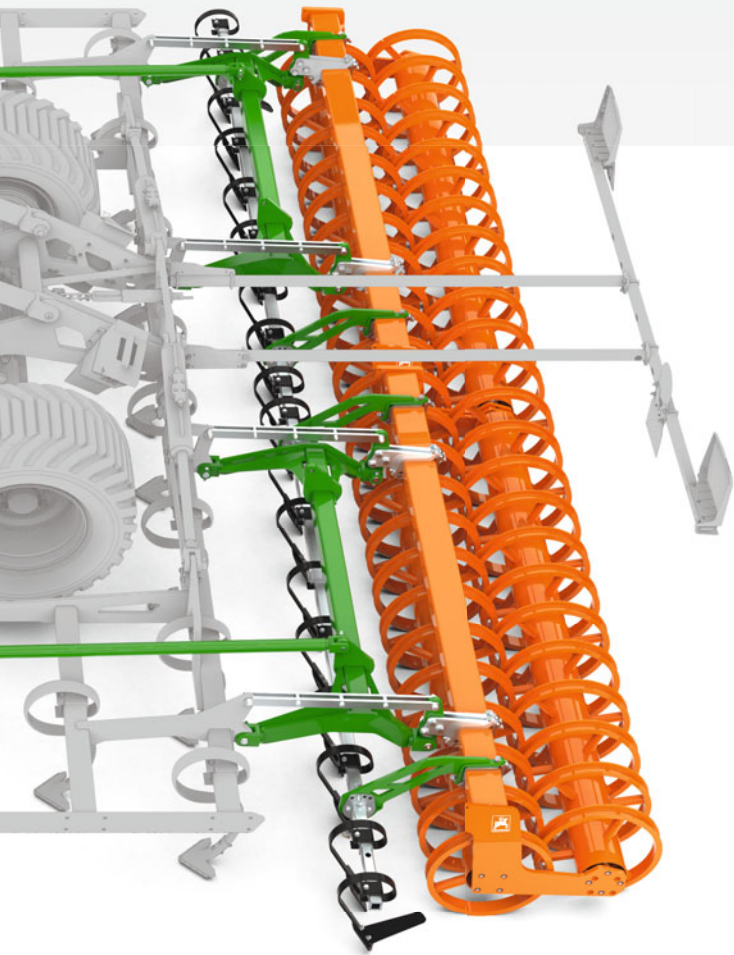

Levelling and roller control

Owing to the parallelogram-guided following roller, a continuous constant surface pressure is applied, even if double rollers are installed. Since the levelling unit is connected directly to the roller, time-consuming working depth adjustment is not required here. The levelling unit consists of trailing tines. It is automatically protected from overload thanks to leaf springs and can be easily deactivated if there is excessive organic matter.



Working depth adjustment from the cab

A coupling rod between the depth control elements provides uniform adjustment at both the front and rear of the machine. The working depth can be adjusted infinitely variably from the tractor cab, to permit individual reaction to the changing conditions within a field. An easy-to-read scale helps with the orientation for the driver. As an alternative, the working depth can also be mechanically adjusted. A spindle is provided on each of the support wheels for this purpose.

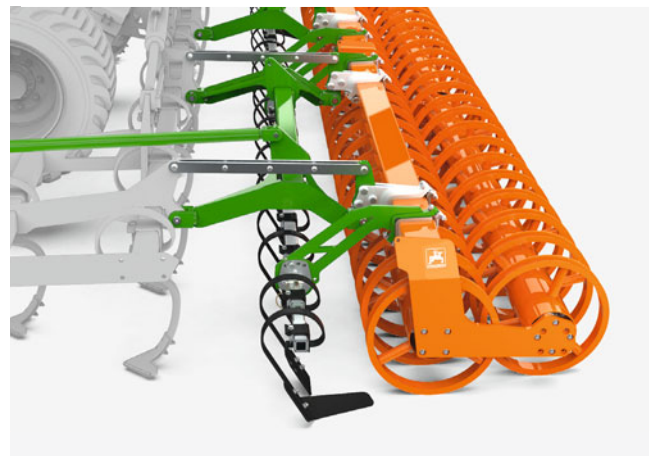

The roller range – reconsolidation and depth control

A wide range of following rollers for reconsolidating the soil are available for all AMAZONE cultivators. Decide which roller suits your farm best!



		Description, diameter	SW cage roller 600 mm				TW tandem roller 520/380 mm			
			-	o	+	++	-	o	+	++
Soil suitability	Light, sticky soils (peat)									
	Light soils (sand)									
	Medium soils									
	Heavy soils									
	Heavy soils (clay)									
Working quality	Crumbling									
	Reconsolidation									
	Self-driving ability (less slip)									
	Carrying capacity									
	Insensitive to stones									
	Insensitive to sticky soils									
	Little tendency to block									
Weight/ m working width			114 kg				160 kg			
Rear harrow			optional				-			

- less suited
o suited

+ well suited
++ very well suited



Roller bearings

All following rollers on AMAZONE cultivators are equipped with bolt-on bearing shafts. This keeps repair work to a minimum in the case of bearing damage. The robust spherical roller bearings provide high reliability and a long service life.

















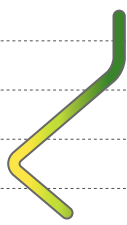
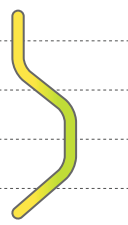
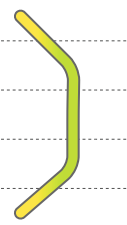

HD roller bearings

The roller bearings are now optionally available in an HD version for maximum operational reliability and an extreme service life.

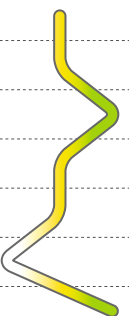
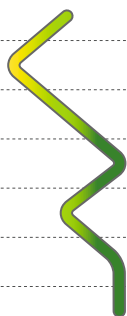
- ✔ Extreme service life thanks to a metallic face seal
- ✔ Completely maintenance-free with life-long lubrication thanks to the gear oil filling
- ✔ Robust and insensitive due to spherical roller bearings instead of ball bearings

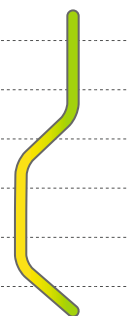
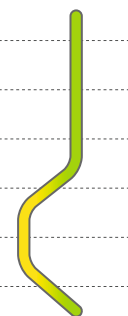

						
UW U-Profile roller 580 mm	DUW Double U-Profile roller 580 mm	KW wedge ring roller 580 mm	KWM wedge ring roller with Matrix tyre profile 600 mm	KWM wedge ring roller with Matrix tyre profile 650 mm	DW disc roller 600 mm	DDU double disc U-profile roller 600 mm
- ○ + ++	- ○ + ++	- ○ + ++	- ○ + ++	- ○ + ++	- ○ + ++	- ○ + ++
						
						
125 kg	185 kg	175 kg	178 kg	205 kg	219 kg	255 kg
optional	optional	optional	optional	optional	optional	-

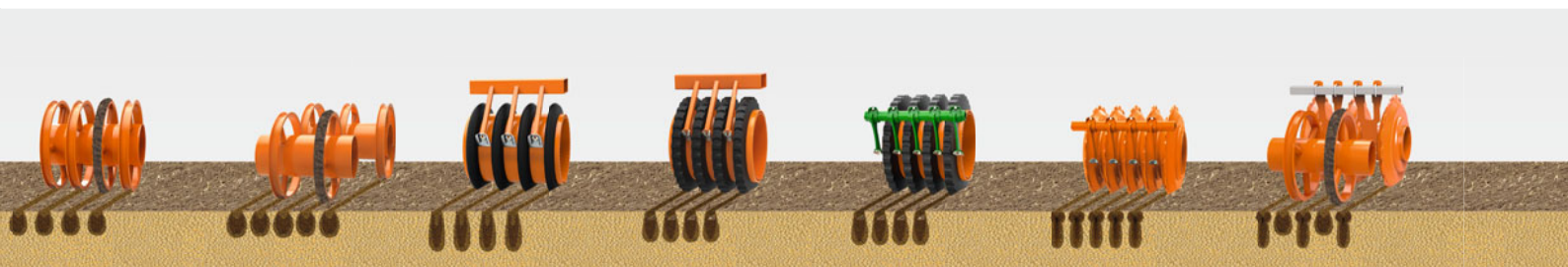

Rear consolidation roller or double harrow

Perfect for shallow soil tillage



Cobra 7000-2TX with double harrow

The perfect supplement for seedbed preparation – in combination with a following roller

For seedbed preparation for maize or sugar beet, the AMAZONE Cobra can also be equipped with a following harrow for many of the rollers. The following harrow creates a very fine-crumbled soil surface structure and thus

the perfect germination conditions for the following crops. An additional advantage when using the harrow is the optimised straw distribution.



Harrow system for SW,
KW and UW following rollers



Harrow system for
KWM & DW following rollers



Harrow system for
DUW following roller



It is simple to change over from a following roller to a double harrow and the other way round, since the roller frame is always used.

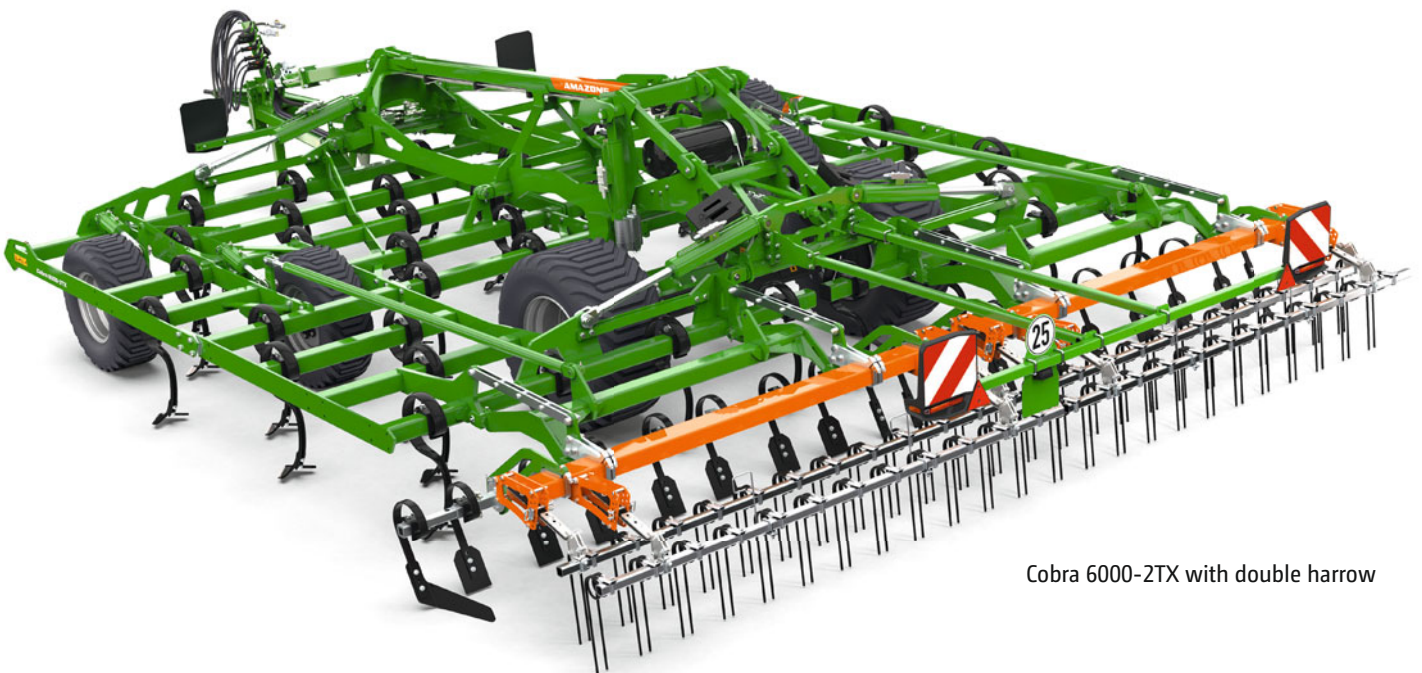

Cobra 6000-2TX with double harrow

The shallow duo – double harrow

The double harrow and duckfoot shares are the ideal combination for mechanical weed control and shallow soil tillage. The Cobra works at a shallow working depth and cuts the weeds off across the full working width.

The following double harrow pulls out the weeds without any further reconsolidation. The germinated weeds and volunteers lie exposed on the soil surface and die.



Double harrow system

GreenDrill

Universal catch crop seeder box for fine seed and catch crops



Cobra 6000-2TX carrying out catch crop sowing

Catch crop sowing and soil tillage in one operational pass

AMAZONE offers the GreenDrill 501 catch crop seeder box for the Cobra enabling the application of catch crops separately or together with the soil tillage. The GreenDrill seeder box has a capacity of 500 l and is easily accessible via steps.



Comfortable operation of the GreenDrill 501 via the ISOBUS terminal

The benefits

- ✔ Application of catch crops and fine seeds during soil tillage
- ✔ High application rates are also possible as a result of different metering rollers
- ✔ Even distribution via baffle plates
- ✔ Safe and convenient access via steps
- ✔ Precise metering with excellent lateral distribution
- ✔ Comfortable machine control via ISOBUS possible, thereby enabling part-area, site-specific processing of application maps

Technical data:

Cobra trailed shallow cultivator

Cobra trailed shallow cultivator	Cobra 6000-2TX	Cobra 7000-2TX
Working width (m)	6.00	7.00
Transport width (m)	2.98	
Transport height (m)	3.50	3.99
Transport length with road lights (m)	8.80–9.70	
Execution	hydraulically folding, trailed	
Weight (minimum / maximum equipment in kg)	5950/8600	6450/9250
No. of tines	45	53
Tine execution	ECO leaf-spring tines	
Number of crossbeams	6	
Tine stagger in the row (cm)	80	
Tine spacing: tine element (cm)	13.3	
Frame height (cm)	60	
Maximum working depth of tine element (cm)	13	
Operational speed (km/h)	10–16	
Maximum transport speed (km/h)	40	
Tyre size of support wheels	380/55-17	
Tyre size of transport wheels	550/45-22.5	
Minimum tractor pulling power (kW/hp)	185/250	215/290
Maximum tractor pulling power (kW/hp)	295/400	350/475
Minimum no. of d/a tractor spool valves	2	
Linkage	Cat. 3, Cat. 4N, drawbar eye or K80 ball	



Illustrations, content and technical data are not binding and may differ depending on the level of equipment. Country-specific road traffic regulations apply and must be complied with, meaning that special approval may be required. The permissible axle loads and total weights of the tractor should be checked. Not all the listed combination options are possible with all tractor manufacturers.



AMAZONE

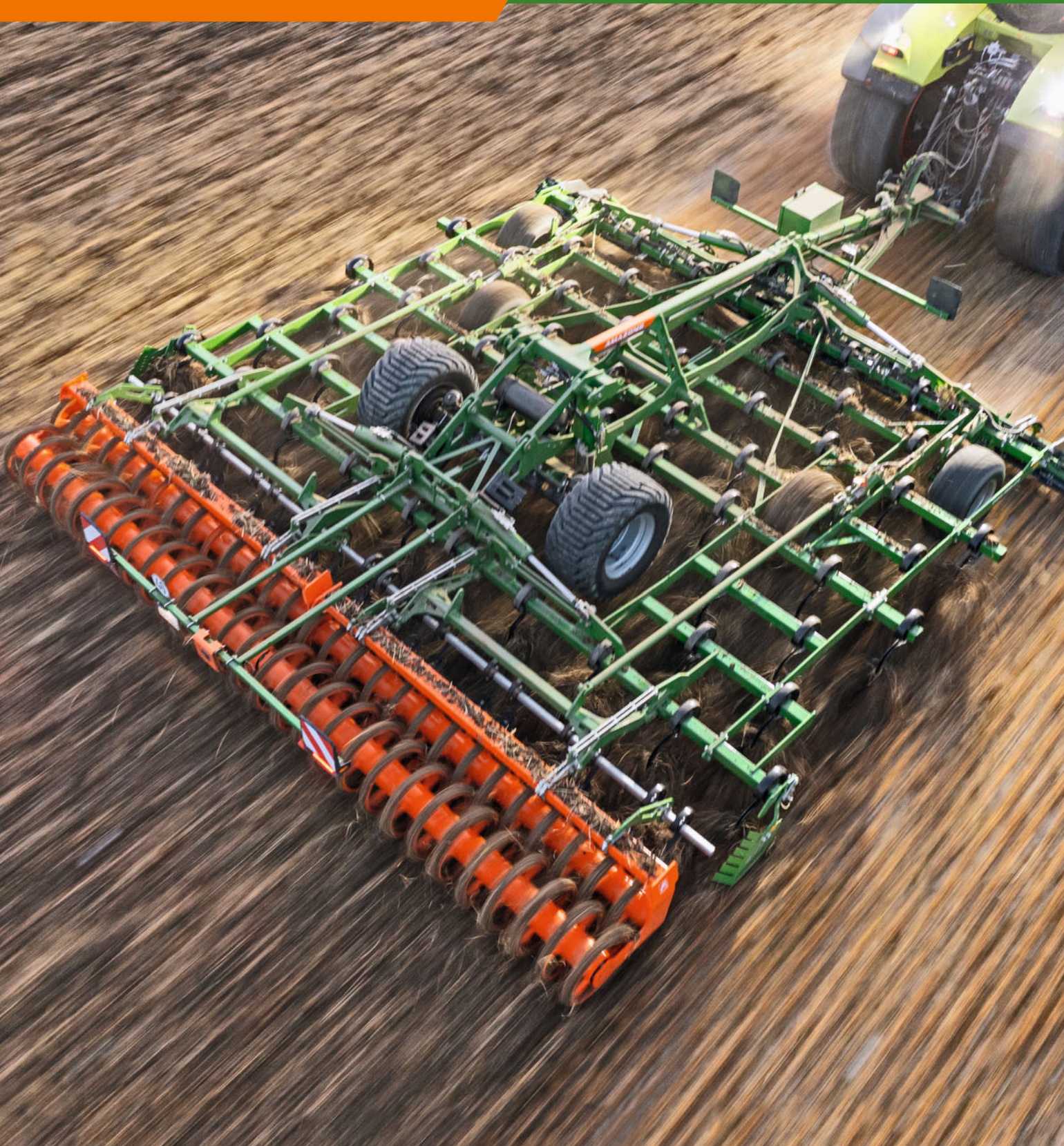

Illustrations, content and technical data are not binding and may differ depending on the level of equipment. Country-specific road traffic regulations apply and must be complied with, meaning that special approval may be required. The permissible axle loads and total weights of the tractor should be checked. Not all the listed combination options are possible with all tractor manufacturers.



AMAZONEN-WERKE H. DREYER SE & Co. KG
P. O. Box 51 · 49202 Hasbergen-Gaste/Germany
Phone +49 (0)5405 501-0 · Fax +49 (0)5405 501-193